

The Albright Product Range

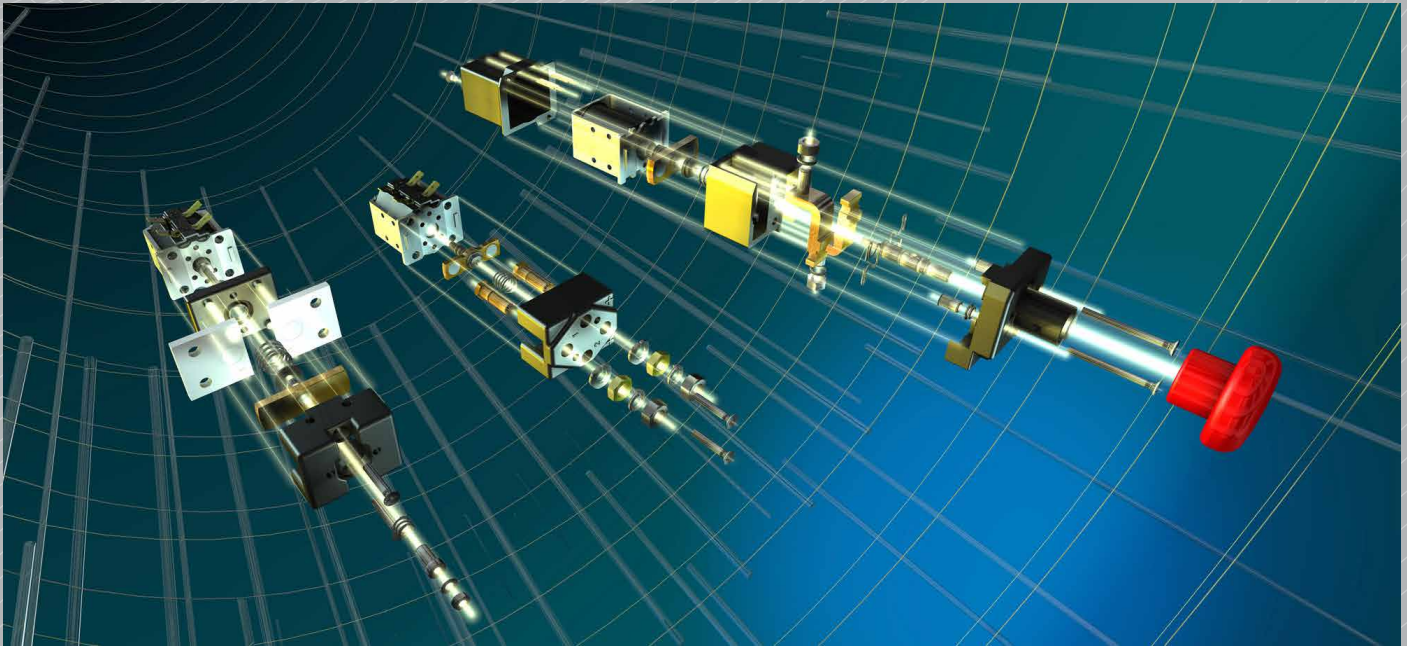

The Albright International product range consists of innovative and original designed contactors and disconnect switches grouped into series based on ampere rating. All our contactors have double breaking main contacts with silver alloy contact tips, which are weld resistant, hard wearing and have excellent conductivity. Detailed here is an introduction to our extensive range of products. For further detailed information concerning individual contactors or disconnect switches please refer to the specific catalogue data sheet, available to download from our web site or by contacting us directly (see footer for contact details).

Contactor Ratings

The majority of our contactors are offered for use with both an Interrupted and Uninterrupted current load. An Interrupted current is when a switch is used to open and close on load. Frequent switching of load current can result in increased contact resistance, which therefore may affect the contactor thermal current rating. An Uninterrupted current is when a switch has no or limited load switching requirements and maintains a lower contact resistance.

The current ratings shown in this brochure are the maximum continuous thermal currents. Some derating may be necessary when the application requires frequent on-load switching. Please consult our technical engineers for advice.

Spare Parts

A full range of spare parts for servicing of existing Albright contactors are available. These include contacts, top covers and coil assemblies, and additionally for the SW80, SW180 and SW200 series we offer complete spare contact kits. P type contactors (e.g. SW80P) are non-serviceable, as disassembling the contactor compromises their IP66 seal.

Technical Support

Our technical support teams are available to offer you advice on all our product ranges, help you select the correct product for your application and answer any of your queries. Our support service is available via our technical email address, telephoning our offices or via your local distributor (please see our Distributors Sheet available from our web site under 'Downloads').

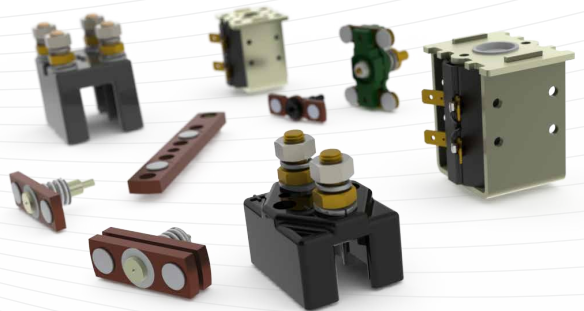

Explanation of the Albright Contactor Part Number

Our contactors are divided into series based on thermal current specification. Each Albright series consists of a number of contactors, which are grouped into types: hence there can be more than one type of contactor within a series. Each type is comprised of contactors grouped according to their configuration, such as Single Pole, Single Throw, Normally Open.

The part number is completed by a unique identity number and the specification of the contactor indicated by a letter suffix. Detailed below are the options available and the associated suffix to the Albright part number.

Contactor Options Suffix Description

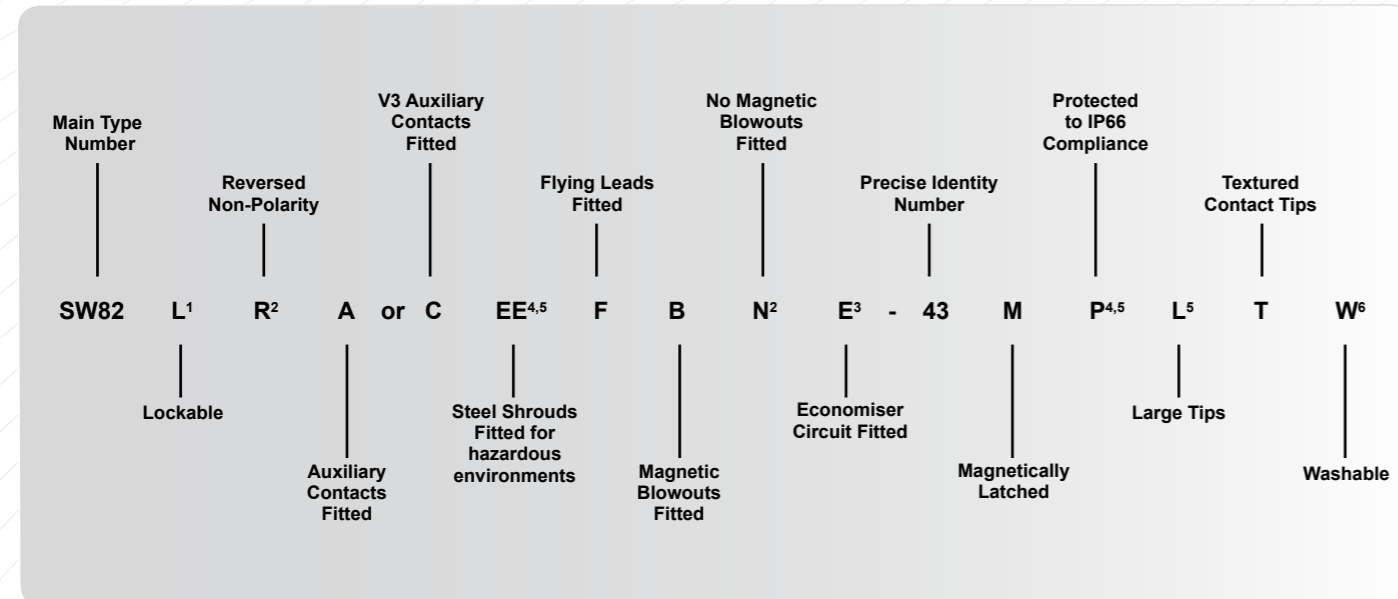

¹ Applicable only to specific ED/SD Types, ² SW200 Series Only, ³ SW120, SW121 & SW132 Series Only, ⁴ Specific types only, ⁵ Not applicable to busbar contactors, ⁶ Applicable only to PC types

Please note: The 'E' contactor option of Economy Pricing is now obsolete

Custom Made Options Available

Whilst we have an extensive range of products, if you can not find a suitable option we offer full design and customisation, ranging from a component through to a complete contactor solution. Should you require a contactor developed for a particular application, depending on overall requirements and volume, Albright can engineer specific designs for our customers.

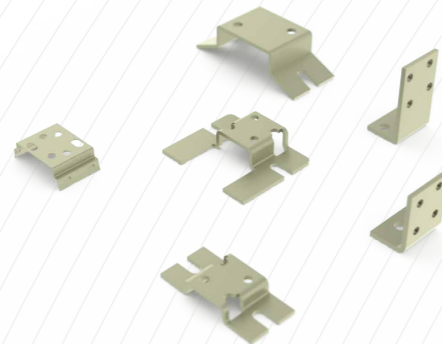
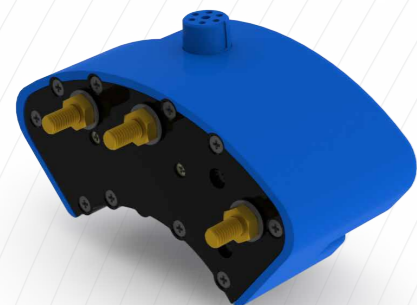

These can be a distinct variation of an existing product, or a complete new product range. Our CAD system and rapid prototyping facilities ensure fast provision of 3 dimensional data and physical samples for your ease of assessment and visualisation.

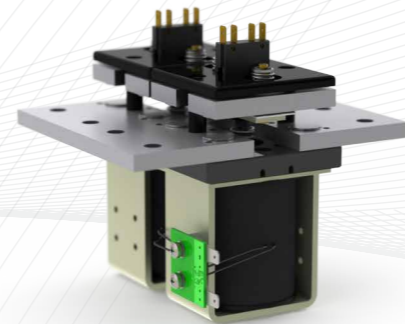

Albright Contactor Options

Our contactors can be provided with a number of options allowing each contactor to be tailored for your specific use. The options available are subject to suitability of the product and application.

General Options

Armature Cap

This is a cap used to cover the exposed coil end of the contactor which provides protection against contamination. An armature cap is not necessary for 'P' types and is not applicable to busbar contactors.

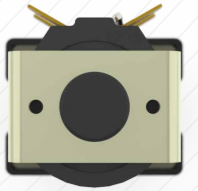

Auxiliary Contacts 'A'/'C'

A changeover microswitch can be fitted which has a D.C. resistive rating of 5 Amperes at 24v (further ratings available). The suffix 'A' should be added to the type number when a standard Albright auxiliary contact is required. The suffix 'C' should be added to the type number when a V3 or V4 auxiliary is required. (The V3/V4 option is an economical alternative to our standard microswitch).

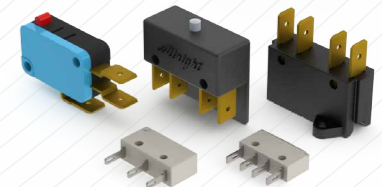

Magnetic Blowouts 'B'

Blowouts enable the contacts to switch D.C. voltages of 48v or higher. Fitting of blowouts usually makes the contacts polarity sensitive and where this is the case the positive markings '+' on the top cover of the contactor must be observed. Magnetic Blowouts can be used with certain 'P' type switches, but we do not advise them suitable for frequent current switching applications. The suffix 'B' denotes the fitting of magnetic blowouts.

Note: The SW200 series is fitted with magnetic blowouts as standard therefore the option is to not have blowouts, this is indicated by the suffix 'N'. Also relevant to the SW200 range is the suffix 'R' which denotes non polarity sensitive blowouts are fitted.

Magnetic Blowouts - High Powered (Super Magnets)

These are high power magnets with greater Gauss allowing for increased power loads, especially high voltages. Offered as an optional extra and fitted within the top cover, there is no increase on the overall dimensions.

Notes: Generally, contacts become polarity sensitive when magnetic blowouts are fitted. This feature can only be fitted to certain types and excludes the busbar mountable types. On the SU190 series, when 'B' is requested high power magnets are fitted as standard.

Steel Shrouds - Type 'EE'

Meeting the requirements of UL583 for Type EE Trucks, these contactors are fitted with steel shrouds which create enclosures around the contact housing area.

Note: These are designed for EE environments and not EX hazardous locations.



Economy Circuit 'E'

Placed in series with the coil via auxiliary contacts, the economy circuit allows for a very strong initial energisation and then provides reduced power consumption on the coil. This allows a strong return spring/coil combination to be utilised, and thus provides the best switching characteristics.

Enclosed Housing/Dust Shields

The aperture usually found in the top cover housing in stud type contactors is closed to form a barrier and limits airborne contamination into the contact area. This is done either through dust shields or where available, an enclosed top cover – both offering the same level of protection.

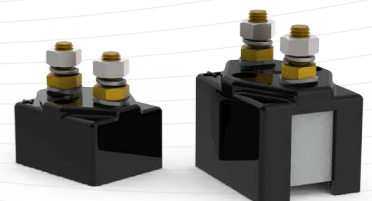

Fuse Holder

Optional to the SD range, the fuse holder is for fitment of an inline fuse direct to the fixed contact, suitable for 51mm & 62mm mounting centres.

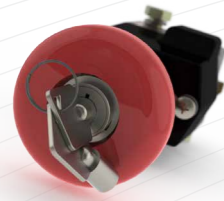

Lockable 'L'

Lockable versions of both the ED and SD types are available. For these versions a key is necessary for the knob to be moved from the "Off" position to the "On" position. Once in the "On" position, the key can be removed. Thereafter, the knob may be depressed to the "Off" position where it will automatically lock and remain locked until the key is used again to unlock it. The suffix 'L' in this circumstance denotes Lockable.

Magnetically Latched 'M'

The contactors can be supplied with magnetic latching - one short pulse to close the main contacts - one short pulse of opposite polarity to re-open them (recommended minimum of 500ms). The result is a bi-stable device, the coil of which consumes no power except during the closing and opening strokes. Since there is in effect no heating of the coil, the contactors can be engineered in the first place with more powerful coils and springs than with conventional contactors. Contact ratings and all external dimensions are identical to those of the equivalent type which have conventionally energised coils.

IMPORTANT NOTES:

- Magnetically latched contactors do not fail safe. If there is a power failure, or if the supply to the contactor coil is broken, the contactor contacts will not open or close i.e. the contactor will not change state. Therefore these devices should not be used in applications where the failure of contacts to open or close could result in a hazardous situation for persons or equipment.
- Magnetic latching should not be used in applications which experience shock or vibration.

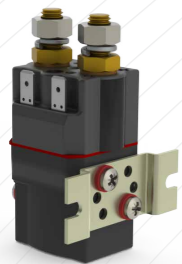

Protected 'P'

Special versions of the SW60, SU60, SW68, SW80, SW82, SU80 and SU280 contactors are available which are protected to IP66 against particularly adverse environments such as water spray, airborne dust and such like. These contactors, which have the suffix 'P' are sealed in an inert plastic case and are fitted with mounting brackets as per their catalogue drawings. Please refer to the individual contactor data sheets for details. Magnetic blowouts can be fitted to most 'P' types.

Washable 'W'

The PC60A-W, PC61A-W and PC63A-W are PC series contactors designed to go through the flux washing processes used in modern PCB production. The auxiliary contacts are supplied separately and the contactors auxiliary actuator hole is temporarily sealed with a rubber plug. After washing the plug can be removed and the auxiliary contact is easily and quickly installed. The PC range fitted with auxiliary contacts cannot be supplied as a Protected (P) Variant.

Contact Options

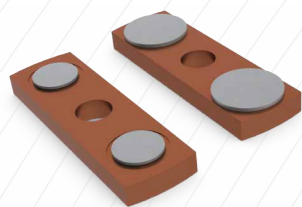

Large Contacts 'L'

Our standard contacts are suitable for the majority of applications where switching conditions are relatively light, particularly on electronically controlled vehicles. However, in applications where more severe conditions exist such as pump motor switching, certain ranges are available with larger contacts which will increase the life of the contactor. The suffix 'L' in this circumstance denotes large contacts.

Silver Plating

Our Busbar range of contactors are plated as standard. Silver plating provides an optimum electrical conductor interface between the contactor and the application, and allows heat to be distributed more efficiently. Plating may be excluded at the customer's option but the effect of temperature rise within the application should be considered.

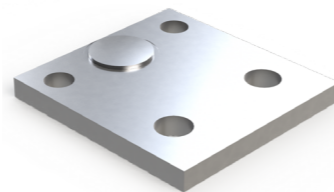

Textured Tips 'T'

These can be supplied where it is desired to pass a low current (<5A) through the tips for monitoring purposes. These are suitable for applications where the contactor is switched off-load only.

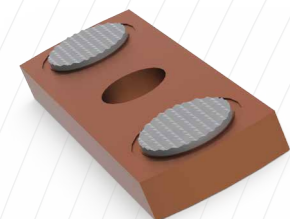

Operating Coils

Coil voltages ranging from 6 to 240v are available which are wound for D.C. operation. However, the majority of coils can be fitted with a bridge rectifier for use with A.C. supplies. Coils are wound with pull-in voltages (coils at 20°C) approximately 66% of the rated voltage (Continuous) or 60% (Prolonged, Intermittent Or Very Intermittent), and drop-out voltage nominally greater than 10% of the rated voltage. Variations from these pull-in and drop-out figures can be engineered to suit particular applications.

Coil Options

AC Rectifier Board

Our coils are wound for Direct Currents however, a rectifier can be supplied fitted for Alternating Current applications. Connection terminals are AMP push fit.

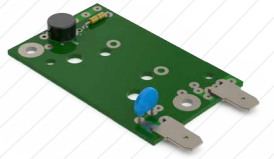

Coil Suppression

Diode or diode and series resistors are available to control transient voltages to an acceptable level; however adding a diode will increase drop out time, adding a resistor will reduce the drop out time but increase the transient voltage. Bidirectional diodes are available to control transients, and while drop out time will increase, this will be reduced in comparison to conventional diodes.

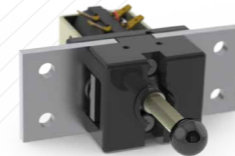
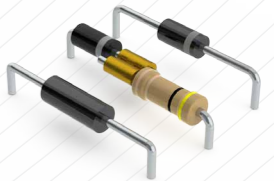

Manual Override Operation

Some contactors can be fitted with a manual override knob which allows the user to manually switch the main contacts.



Vacuum Impregnation

This option will allow for protection against shock, vibration and high humidity. Coil terminal options available are AMP tags and flying leads.

Coil Terminal Options

AMP Push Fit

The standard coil termination for Albright, offers either 6.3mm or 4.7mm push fit coil termination.

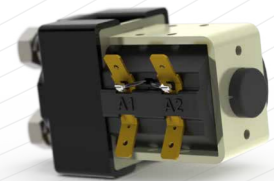

Flying Leads 'F'

Leads with a variety of terminations can be used to aid installation. Length of the leads can be determined by the customer.



Plug

Compatible with Tyco part number 282189, this is a mechanically fastened terminal, widely used in the automotive industry.

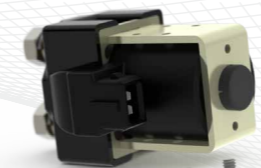

M4/M5 Terminal Board/Stud Fitting

An option which allows the connection of suitable ring terminals to the coil, and replaces standard push fit terminals. The SW60 series and all 'P' type contactors have only the option of M4 stud terminals, which are mounted to the AMP terminals.

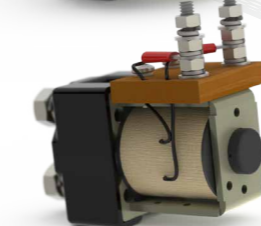

Custom Made Alternatives

If our standard options are not suitable for your needs, we have alternative options available, please contact our technical department for further details.

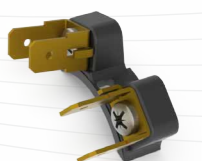

Mounting Bracket Options

As well as tapped holes on the contactor, Albright offer a wide range of brackets. Generally these are split into a 'Top Hat' style for mounting parallel to the mounting surface or an 'L' shape mounting bracket for mounting 90 degrees to the surface. Albright can also design and/or manufacture customer specific solutions. See Series Catalogues for details of specific mounting bracket options.

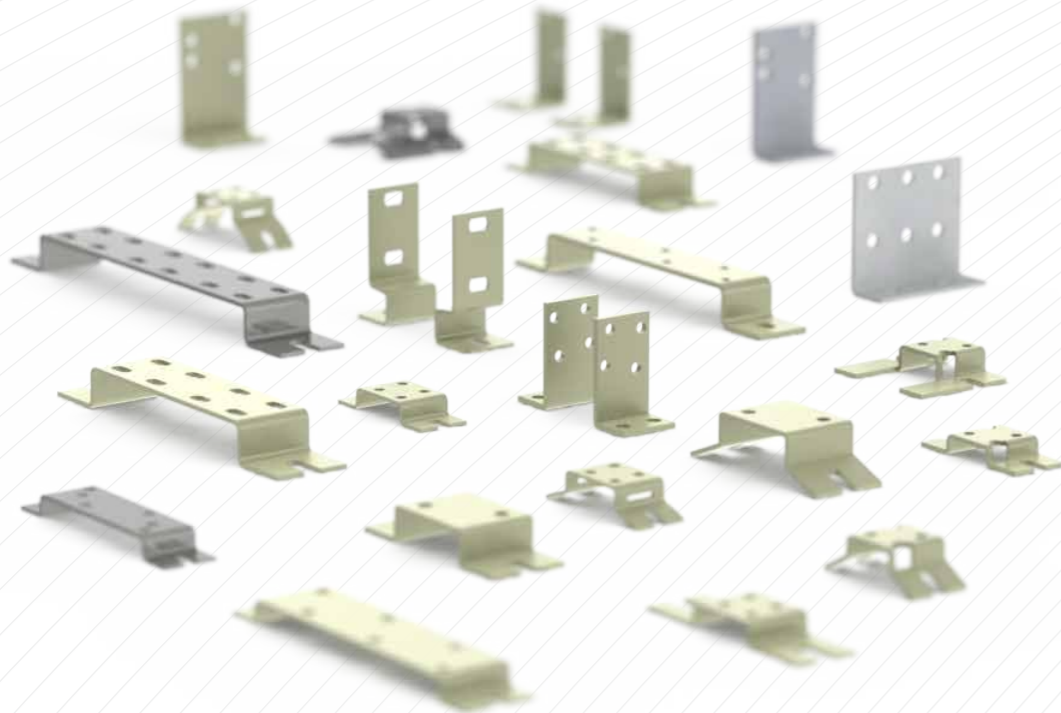

Standards & Accreditation

Quality and the Environment are key concerns at Albright. The group is accredited with:

- BS EN ISO 9001:2008 (QMS for Design and Manufacture of Electrical Equipment)
- ISO 14001:2004 (Environmental Management System)

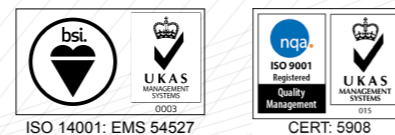

Should you require any information on the disposal of our products, please contact our Health, Safety & Environmental Manager or your Local Supplier for our Disposal Guidance Note.

Furthermore, to aid customers, selected products have 3rd party Certification/Recognition, as follows:

EU Standard:

- BS EN 61373 : 1999 (Shock and Vibration)

Chinese Standard:

- Chinese Compulsory Certification - CCC



Underwriters Laboratories:

- AU2378 Industrial Truck Accessories, Battery Powered
- E165921 Power Distribution Centre for Telecommunications Equipment
- E181430 Switches, Industrial Control - Component



In addition, Albright is compliant with the Restriction of Hazardous Substances (RoHS) Directive ensuring the safe removal of hazardous material from all products. The removal of cadmium from silver tips and the elimination of lead products are some of the key actions implemented to ensure compliance.

SW60 Series Contactors

The SW60 series are miniature Direct Current contactors designed to fill the gap between 30 ampere relays and 100 ampere contactors. The series is divided into three distinct branches; PC60 for printed circuit board mounting, SW60 which are free standing contactors and DC66P, a standard IP66 rated motor reversing contactor. Each series has its own selection of variations, suitable for uninterrupted and interrupted loads.



SW68

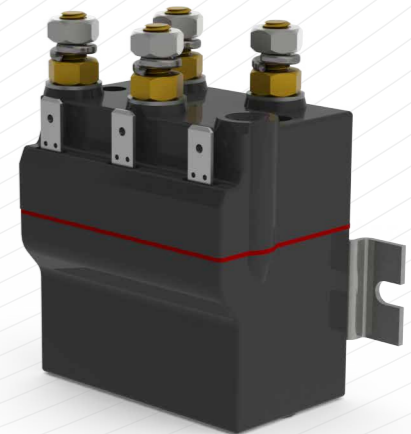

DC66P

SW60 Miniature Series Contactor

Contactor Type	Description	Maximum Continuous Current Thermal Rating	
		Interrupted	Uninterrupted
SW60	Single Pole Single Throw Normally Open	80 Amperes	
SW60P	Single Pole Single Throw Normally Open - IP66 compliant	80 Amperes	
SW61	Single Pole Double Throw	80 Amperes	
SW63	Single Pole Single Throw Normally Closed	80 Amperes	
SW63P	Single Pole Single Throw Normally Closed - IP66 compliant	80 Amperes	
SW64	2 x SW60 on Double Bracket	80 Amperes	
SW64P	2 x SW60 on Double Bracket - IP66 compliant	80 Amperes	
SW66	2 x SW61 on Double Bracket for Motor Reversing	80 Amperes	
SW66P	2 x SW61 on Double Bracket for Motor Reversing - IP66 compliant	80 Amperes	
SW68	Double Pole Single Throw Normally Open	80 Amperes	
SW68P	Double Pole Single Throw Normally Open - IP66 compliant	80 Amperes	
SW688	2 x SW68	80 Amperes	
SW688P	2 x SW68P - IP66 compliant	80 Amperes	
DC64P	Monoblock, 2 x SW60 - IP66 compliant	80 Amperes	
DC66P	Monoblock, Single Pole Double Throw for Motor Reversing - IP66 compliant	80 Amperes	

Please refer to individual Catalogue sheet for further Type details

PC60 Miniature Series PCB Mounted Contactor

Contactor Type	Description	Maximum Continuous Current Thermal Rating	
		Interrupted	Uninterrupted
PC60	Single Pole Single Throw Normally Open	80 Amperes	
PC60P	Single Pole Single Throw Normally Open - IP66 compliant	80 Amperes	
PC61	Single Pole Double Throw	80 Amperes	
PC61P	Single Pole Double Throw - IP66 compliant	80 Amperes	
PC63	Single Pole Single Throw Normally Closed	80 Amperes	
PC63P	Single Pole Single Throw Normally Closed - IP66 compliant	80 Amperes	
MB60	Single Pole Single Throw Normally Open with mounting base	80 Amperes	
MB61	Single Pole Double Throw with mounting base	80 Amperes	
MB63	Single Pole Single Throw Normally Closed with mounting base	80 Amperes	

Please refer to individual Catalogue sheet for further Type details



PC60

Albright International Product Range

SW80 Series Contactors

The "SW80" series of contactors have been designed for direct current loads, particularly motors as used on small electric vehicles such as light industrial trucks and powered cars. Suitable for Interrupted and Uninterrupted loads, they are also used extensively for power distribution systems.

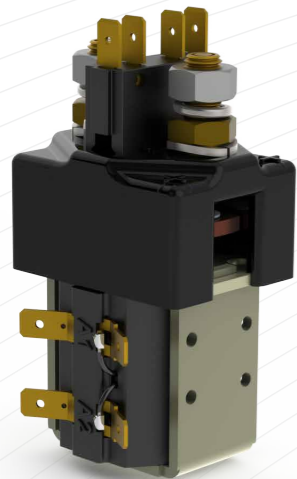

SW80A



SW80P



SW84A

Contactor Type	Description	Maximum Continuous Current Thermal Rating	
		Interrupted	Uninterrupted
SW80	Single Pole Single Throw Normally Open	100 Amperes	125 Amperes
SW80E	Single Pole Single Throw Normally Open (Reduced Specification - Economy Version) <i>Obsolete. Replaced by SU60 for new applications.</i>	100 Amperes	N/A
SW80PE	Single Pole Single Throw Normally Open - IP66 compliant (Reduced Specification - Economy Version) <i>Obsolete. Replaced by SU60P for new applications.</i>	100 Amperes	N/A
SW80 Plug	Single Pole Single Throw Normally Open - connector plug fitted	100 Amperes	125 Amperes
SW80P	Single Pole Single Throw Normally Open - IP66 compliant	100 Amperes	125 Amperes
SW82	Double Pole Single Throw Normally Open	100 Amperes	
SW82 Plug	Double Pole Single Throw Normally Open - connector plug fitted	100 Amperes	
SW82P	Double Pole Single Throw Normally Open - IP66 compliant	100 Amperes	
SW822	Paired Double Pole Single Throw for Motor Reversing	100 Amperes	
SW822 Plug	Paired Double Pole Single Throw for Motor Reversing - connector plug fitted	100 Amperes	
SW822P	Paired Double Pole Single Throw for Motor Reversing - IP66 compliant	100 Amperes	
SW84	Single Pole Double Throw	100 Amperes	125 Amperes N/O 100 Amperes N/C
SW84 Plug	Single Pole Double Throw - connector plug fitted	100 Amperes	125 Amperes N/O 100 Amperes N/C
SW85	Single Pole Single Throw Normally Closed	100 Amperes	
SW85P	Single Pole Single Throw Normally Closed - IP66 compliant	100 Amperes	
SW86	2 x SW84	100 Amperes	125 Amperes N/O 100 Amperes N/C
DC88	Monoblock Single Pole Double Throw for Motor Reversing	100 Amperes	
DC88P	Monoblock Single Pole Double Throw for Motor Reversing - IP66 compliant	100 Amperes	
SW88	2 x SW84 on Common Bracket for Motor Reversing	100 Amperes	
DC90	Monoblock, 1 x SW80 & 1 x SW84	100 Amperes	125 Amperes N/O 100 Amperes N/C
SW90	1 x SW80 & 1 x SW84 on Double Bracket	100 Amperes	125 Amperes N/O 100 Amperes N/C
DC92	Monoblock, 2 x SW80	100 Amperes	125 Amperes
DC92P	Monoblock, 2 x SW80 - IP66 compliant	100 Amperes	125 Amperes
SW92	2 x SW80 on Double Bracket	100 Amperes	125 Amperes
SW92P	2 x SW80 on Double Bracket - IP66 compliant	100 Amperes	125 Amperes
SW93	2 x SW85 on Double Double Bracket	100 Amperes	
SW93P	2 x SW85 on Double Double Bracket - IP66 compliant	100 Amperes	
SW95	1 x SW80 + 1 x SW82	100 Amperes	
SW95P	1 x SW80P + 1 x SW82P - IP66 Compliant	100 Amperes	
SW96	1 x SW80 + 1 x SW85	100 Amperes	

Please refer to individual Catalogue sheet for further Type details

SW120 Series Contactors

The SW120 series of contactors have been designed for Direct Current loads, particularly motors as used on small electric vehicles such as light industrial trucks and powered cars. These contactors are not polarity sensitive thus they can be used for switching Alternating Current loads.



SW120A

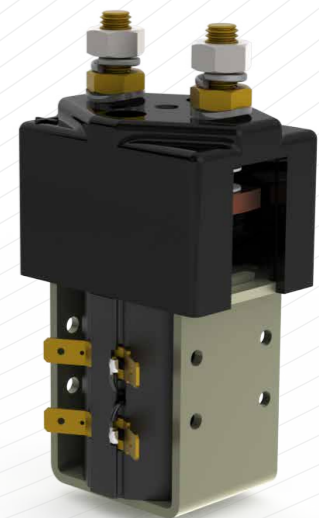

SW180



SW190A

Contactor Type	Description	Maximum Continuous Current Thermal Rating	
		Interrupted	Uninterrupted
SW120	Double Pole Single Throw Normally Open	125 Amperes	
SW120E	Double Pole Single Throw Normally Open (Economy Circuit Fitted)	125 Amperes	
SW121	Double Pole Double Throw	125 Amperes	125 Amperes N/O 100 Amperes N/C
SW121E	Double Pole Double Throw (Economy Circuit Fitted)	125 Amperes	125 Amperes N/O 100 Amperes N/C
SW122	2 x SW120 on Common Bracket for Motor Reversing	125 Amperes	
SW123	2 x Double Pole Double Throw	125 Amperes	125 Amperes N/O 100 Amperes N/C
SW132	Double Pole Single Throw Normally Closed	100 Amperes	
SW132E	Double Pole Single Throw Normally Closed (Economy Circuit Fitted)	125 Amperes	125 Amperes N/O 100 Amperes N/C
SW133	Paired Double Pole Single Throw Normally Closed on Common Bracket	125 Amperes	

Please refer to individual Catalogue sheet for further Type details

SW180 & 190 Series Contactors

The SW180 and SW190 series of contactors have been designed for Direct Current loads, particularly motors as used on electric vehicles such as industrial trucks and airport tractors. They are also used for power distribution.

Contactor Type	Description	Maximum Continuous Current Thermal Rating	
		Interrupted	Uninterrupted
SW180	Single Pole Single Throw Normally Open	150 Amperes	200 Amperes
SW181	Single Pole Double Throw	150 Amperes	200 Amperes N/O 150 Amperes N/C
DC182	Monoblock Single Pole Double Throw for Motor Reversing	150 Amperes	
SW182	2 x SW181 on Common Bracket for Motor Reversing	150 Amperes	
DC184	Monoblock, 2 x SW180	150 Amperes	200 Amperes
SW184	2 x SW180 on Common Bracket	150 Amperes	200 Amperes
SW185	Single Pole Single Throw Normally Closed	150 Amperes	
SW188	2 x SW181 or 1 x SW181 + 1 x SW180	150 Amperes	200 Amperes N/O 150 Amperes N/C
SW189	2 x SW185 on Common Bracket	150 Amperes	
SW190	Double Pole Single Throw Normally Open	150 Amperes	200 Amperes
SW192	2 x SW190 on Common Bracket for Motor Reversing	150 Amperes	200 Amperes
SW195	Double Pole Single Throw Normally Closed	150 Amperes	

Please refer to individual Catalogue sheet for further Type details

Albright International Product Range

SW200 Series Contactors

The SW200 series of contactors have been designed for Direct Current loads, originally for motors as used on electric vehicles, such as industrial trucks and airport tractors. However, they are also employed in all scopes of applications including power distribution.



SW200

Contactor Type	Description	Maximum Continuous Current Thermal Rating	
		Interrupted	Uninterrupted
SW200	Single Pole Single Throw Normally Open	250 Amperes	400 Amperes
SW201	Single Pole Double Throw	250 Amperes	400 Amperes N/O 250 Amperes N/C
SW202	2 x SW201 on Common Bracket for Motor Reversing	250 Amperes	
SW204	2 x SW200 on Common Bracket	250 Amperes	400 Amperes
SW205	2 x SW201 on common Bracket	250 Amperes	400 Amperes N/O 250 Amperes N/C
SW208	3 x SW200 on Common Bracket	250 Amperes	400 Amperes
SW210	Single Pole Single Throw Normally Closed	250 Amperes	
SW213	3 x SW210 on Common Bracket	250 Amperes	
SW214	2 x SW210 on Common Bracket	250 Amperes	
SW215	Single Pole Double Throw Normally Closed on Stud Contacts	250 Amperes	

Please refer to individual Catalogue sheet for further Type details



SU60A

SU Series Contactors

The SU series of contactors offer an economical and space saving solution to consider as an alternative to standard part numbers. Depending on suitability for the application, the contactors are reliable and robust and are typically employed for both Interrupted and Uninterrupted loads.

Contactor Type	Description	Maximum Continuous Current Thermal Rating	
		Interrupted	Uninterrupted
SU60	Single Pole Single Throw Normally Open	100 Amperes	
SU60P	Single Pole Single Throw Normally Open – IP66 compliant	100 Amperes	
SU80	Single Pole Single Throw Normally Open	150 Amperes	200 Amperes
SU80 Plug	Single Pole Single Throw Normally Open – connector plug fitted	150 Amperes	200 Amperes
SU80P	Single Pole Single Throw Normally Open – IP66 compliant	150 Amperes	200 Amperes
SU190	Double Pole Single Throw Normally Open	250 Amperes	350 Amperes
SU190 Plug	Double Pole Single Throw Normally Open – connector plug fitted	250 Amperes	350 Amperes
SU192	2 x SU190 on Common Bracket for Motor Reversing	250 Amperes	350 Amperes
SU280	Single Pole Single Throw Normally Open	250 Amperes	350 Amperes
SU280 Plug	Single Pole Single Throw Normally Open – connector plug fitted	250 Amperes	350 Amperes
SU280P	Single Pole Single Throw Normally Open – IP66 compliant	250 Amperes	350 Amperes
SU284	2 x SU280	250 Amperes	350 Amperes
SU284P	2 x SU280P – IP66 compliant	250 Amperes	350 Amperes
SU285	Single Pole Single Throw Normally Closed	250 Amperes	
SU285 Plug	Single Pole Single Throw Normally Closed – connector plug fitted	250 Amperes	
SU285P	Single Pole Single Throw Normally Closed – IP66 compliant	250 Amperes	

Please refer to individual Catalogue sheet for further Type details

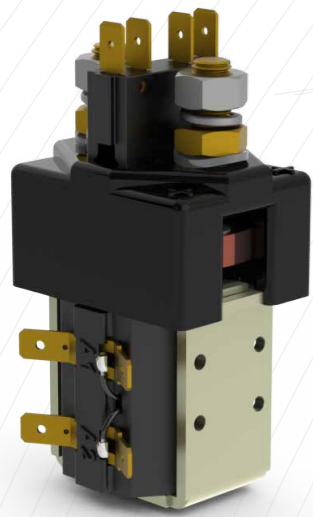

SU80A

Busbar Series Contactors

The Busbar Series of contactors have been designed for use in telecommunication and power distribution applications where an uninterrupted load is switched. These contactors are primarily for use with Direct Current loads but can also be used with Alternating Currents.

Contactor Type	Description	Maximum Continuous Current Thermal Rating
		Uninterrupted
SW140	Single Pole Single Throw Normally Open – Contactor size suitable for a 1U rack installation	140 Amperes
SW150	Single Pole Single Throw Normally Open	150 Amperes
SW225	Single Pole Single Throw Normally Open – Contactor size suitable for a 1U rack installation	225 Amperes
SW250	Single Pole Single Throw Normally Open	250 Amperes
SW260	Single Pole Single Throw Normally Open <i>Replaced by SW300 for new applications.</i>	300 Amperes
SW300	Single Pole Single Throw Normally Open	300 Amperes
SW400	Single Pole Single Throw Normally Open	400 Amperes
SW500	Single Pole Single Throw Normally Open	500 Amperes
SW520	Double Pole Single Throw Normally Open	500 Amperes
SW560	Single Pole Single Throw Normally Open	600 Amperes
SW600	Single Pole Single Throw Normally Open <i>Replaced by SW560 for new applications.</i>	600 Amperes
SW602	2 x Single Pole Single Throw Normally Open	600 Amperes
SW800	Single Pole Single Throw Normally Open	800 Amperes
SW802	Single Pole Double Throw	800 Amperes
SW1000	Single Pole Single Throw Normally Open	1200 Amperes
SW1002	Single Pole Double Throw	1200 Amperes
SW1500	Single Pole Single Throw Normally Open	1800 Amperes
SW1502	Single Pole Double Throw	1800 Amperes
SW2000	Single Pole Single Throw Normally Open	2000 Amperes
SW2400	Single Pole Single Throw Normally Open	2400 Amperes

Please refer to individual Catalogue sheet for further Type details

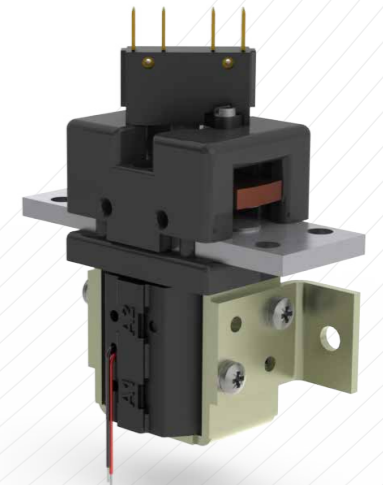

SW225AM

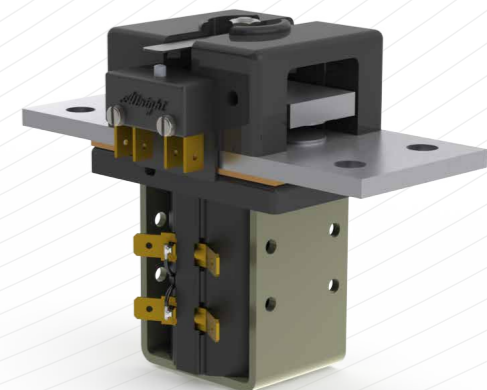

SW400A

Control Units

Our control units are solid state devices designed to time or control switching in order to limit power consumption and prevent coil overheating.

Unit Type	Description
TU150	Time Delay Unit – to delay the operation of an electrical circuit for a preset period.
CC58	Chopped Coil Unit – This controller is used to reduce the power consumption of a standard contactor coil.
ML52	Magnetically Latched Unit – This controller automatically alternates the supply polarity every time the unit is energised.
ML53	Magnetically Latched Unit – This controller has two electrical inputs, the one will always give an "on" pulse, the other will always give an "off" pulse.

Please enquire for available voltages



ML52

Albright International Product Range

Heavy Duty D.C. Battery Disconnecting Switches

The “ED” & “SD” ranges of disconnecting switches have been designed to provide a rapid means of disconnecting batteries or other power supplies in the event of serious electrical faults. The switches are primarily intended for use with battery powered vehicles but are also suitable for use with static power systems. All types are capable of safely rupturing full load battery currents in the event of an emergency. The switch is to be used to rupture current in an emergency or as a no-load isolator. Do not use as a regular On-Load switching device.

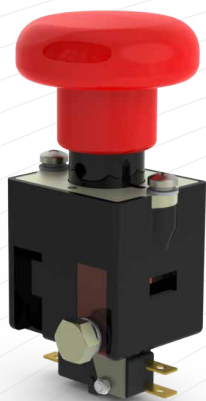

ED150A

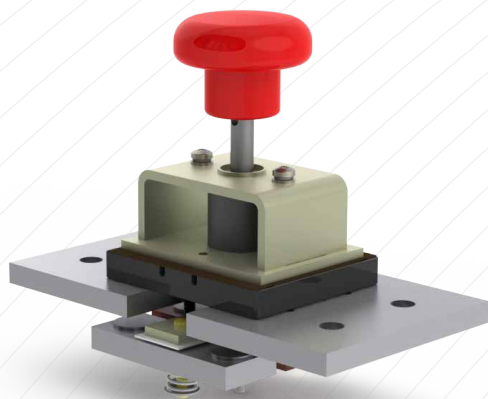

ED1800

ED Series - Manual Disconnect Switches

ED Type	Description	Maximum Continuous Current Thermal Rating	
		Interrupted	Uninterrupted
ED80	Single Pole On/Off	N/A	80 Amperes
ED125	Single Pole On/Off	N/A	125 Amperes
ED125A	Single Pole On/Off with Auxiliary	N/A	125 Amperes
ED125L	Single Pole On/Off - Lockable Version	N/A	125 Amperes
ED125LA	Single Pole On/Off with Auxiliary - Lockable Version	N/A	125 Amperes
ED150	Single Pole On/Off	N/A	150 Amperes
ED200	Single Pole On/Off	N/A	200 Amperes
ED250	Single Pole On/Off	N/A	250 Amperes
ED250A	Single Pole On/Off with Auxiliary	N/A	250 Amperes
ED250L	Single Pole On/Off - Lockable Version	N/A	250 Amperes
ED250LA	Single Pole On/Off with Auxiliary - Lockable Version	N/A	250 Amperes
ED252	Double Pole On/Off	N/A	250 Amperes
ED252A	Double Pole On/Off with Auxiliary	N/A	250 Amperes
ED252L	Double Pole On/Off - Lockable Version	N/A	250 Amperes
ED252LA	Double Pole On/Off with Auxiliary - Lockable Version	N/A	250 Amperes
ED402	Double Pole On/Off	N/A	400 Amperes
ED402A	Double Pole On/Off with Auxiliary	N/A	400 Amperes
ED402L	Double Pole On/Off - Lockable Version	N/A	400 Amperes
ED402LA	Double Pole On/Off with Auxiliary - Lockable Version	N/A	400 Amperes
ED1200	Single Pole Single Throw On/Off	N/A	1200 Amperes
ED1200A	Single Pole Single Throw On/Off with Auxiliary	N/A	1200 Amperes
ED1800	Single Pole Single Throw On/Off	N/A	1800 Amperes
ED1800A	Single Pole Single Throw On/Off with Auxiliary	N/A	1800 Amperes

Please refer to individual Catalogue sheet for further Type details

SD Series - Combined Manual Disconnect & Line Contactor



SD300

SD Type	Description	Maximum Continuous Current Thermal Rating	
		Interrupted	Uninterrupted
SD150	Single Pole On/Off with Manual Disconnect	125 Amperes	
SD150A	Single Pole On/Off with Manual Disconnect and Auxiliary	125 Amperes	
SD150L	Single Pole On/Off with Manual Disconnect - Lockable version	125 Amperes	
SD150LA	Single Pole On/Off with Manual Disconnect and Auxiliary - Lockable version	125 Amperes	
SD200	Single Pole On/Off with Manual Disconnect	200 Amperes	
SD200A	Single Pole On/Off with Manual Disconnect and Auxiliary	200 Amperes	
SD250	Single Pole On/Off with Manual Disconnect	250 Amperes	
SD250A	Single Pole On/Off with Manual Disconnect and Auxiliary	250 Amperes	
SD250L	Single Pole On/Off with Manual Disconnect - Lockable version	250 Amperes	
SD250LA	Single Pole On/Off with Manual Disconnect and Auxiliary - Lockable version	250 Amperes	
SD300	Single Pole On/Off with Manual Disconnect	300 Amperes	
SD300A	Single Pole On/Off with Manual Disconnect and Auxiliary	300 Amperes	

Please refer to individual Catalogue sheets for further Type details

Notes: Fuse holder option available for SD200 & SD300 ranges. Lockable versions not currently available on SD200 & SD300 ranges